

Winkelkonus
Angle cone

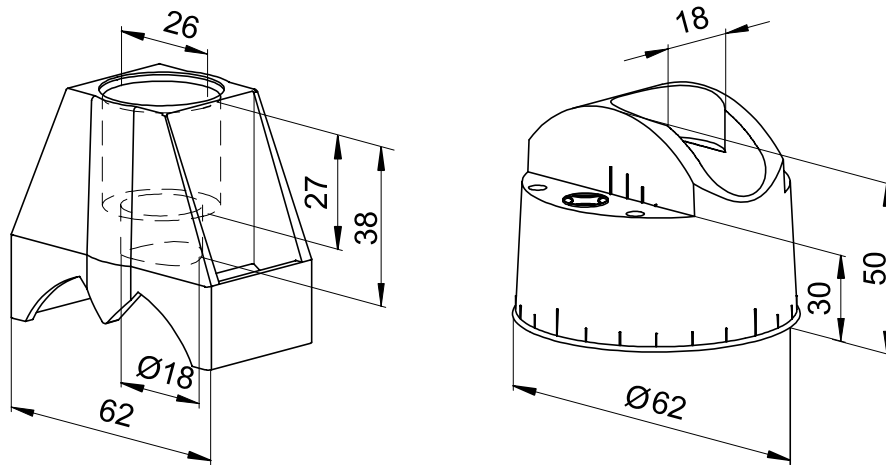

Teile	Gewicht [kg/100 Stck.]	Artikel-Nr.
Winkelkonus komplett 2-tlg.	5,55	511845
Basiskonus, wiedergewinnbar	3,35	511846
Aufsatzwinkel, verloren	2,20	511847

Parts	Weight [kg/100 units]	Item No.
angle-cone, complete, 2-part	5.55	511845
basic cone, recoverable	3.35	511846
headpiece, non-recoverable	2.20	511847

Ausbauwerkzeug
Removing tool

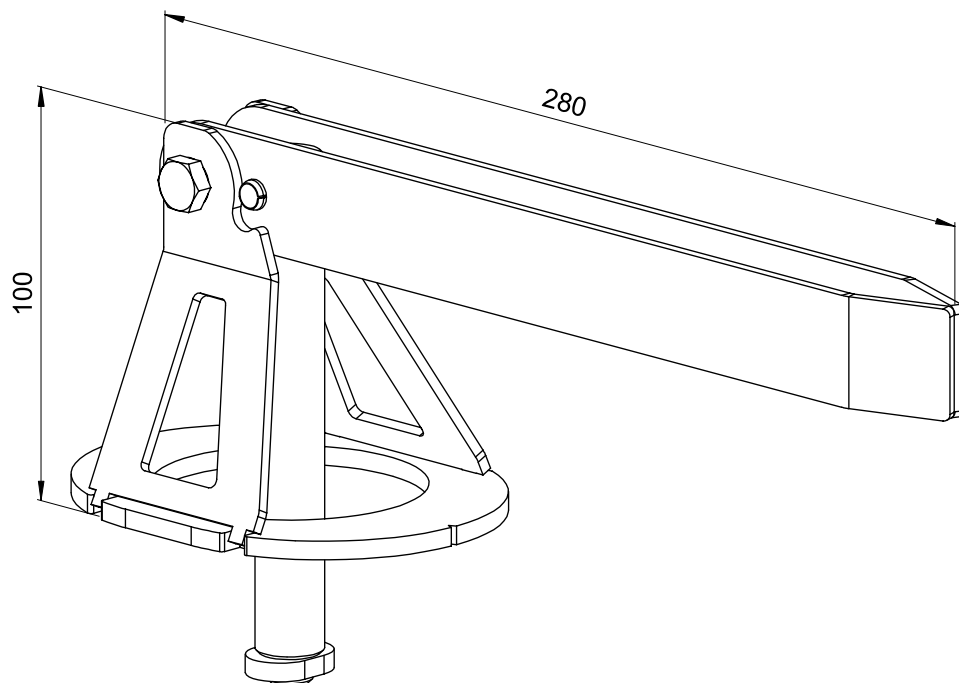

Gewicht [kg/Stck.]	Artikel-Nr.
1,08	511899

Weight [kg/unit]	Item No.
1.08	511899

Hauptsitz:

D-71263 Weil der Stadt-Hausen · Brunnenstraße 36
Tel. +49 70 33 53 71 -0 · Fax +49 70 33 53 71-31
E-Mail: info@robusta-gaukel.de

Niederlassung:

D-12099 Berlin (Tempelhof) · Rohdestraße 19
Tel. +49 30 75 70 70 00 · Fax +49 30 75 70 70 07
E-Mail: nl-berlin@robusta-gaukel.de

Copyright © Januar 2015 ROBUSTA-GAUKELE GMBH & CO. KG
Technische Änderungen vorbehalten
Products may be subject to technical changes